

The RYCO Field Attachable system consists of six ferrule styles, each specific to a hose type, and one common insert. Field attachable inserts and ferrules can be ordered individually, or as a complete coupling for specific hose types.

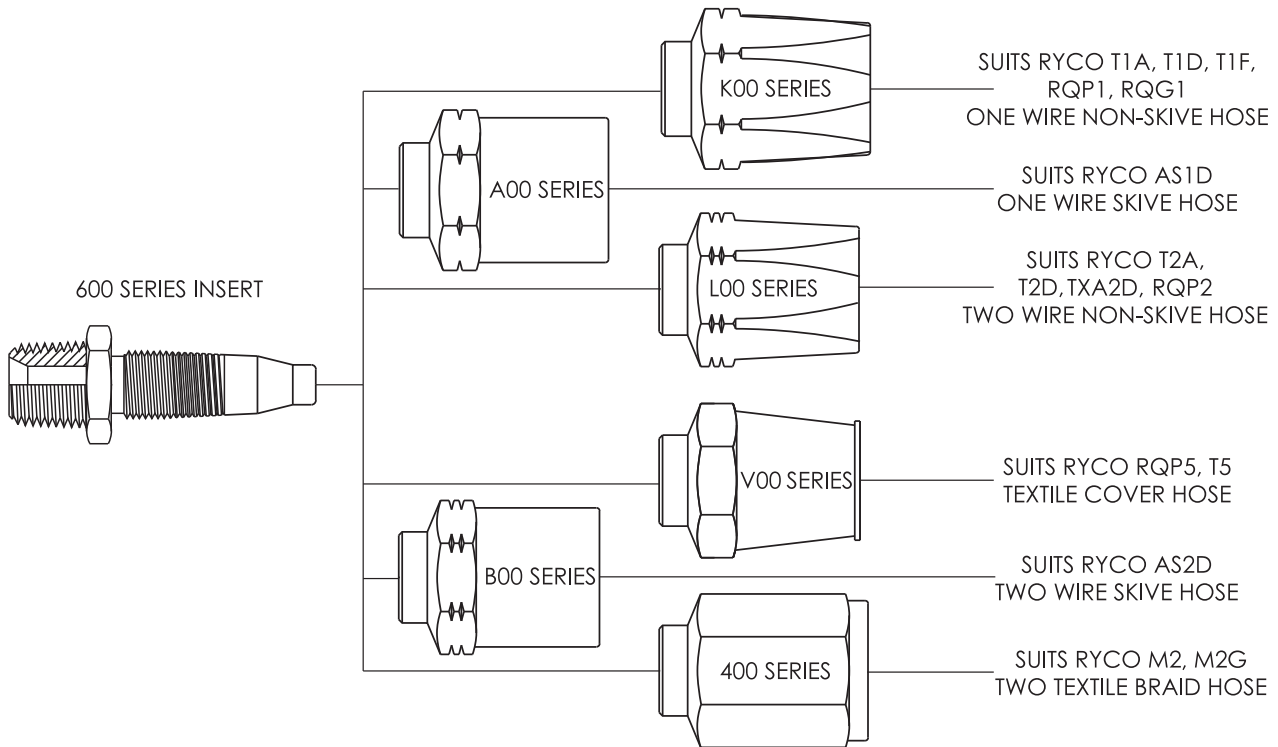

V00 Series Couplings for T5 Hose Series are shown on pages 190 to 201.

600 Series Inserts, for use with A00, B00, K00, L00 and 400 Series Ferrules, are shown on pages 204 to 219.

FERRULES			A00	B00	K00	L00	400						
SUITS RYCO HOSE TYPE			ONE WIRE BRAID SKIVE	TWO WIRE BRAID SKIVE	ONE WIRE BRAID NON-SKIVE	TWO WIRE BRAID NON-SKIVE	TWO TEXTILE BRAID						
SUITS RYCO HOSE SERIES			RYCO AS1D	RYCO AS2D	RYCO T1A, T1D, T1F RQP1, RQP1	RYCO T2A, T2D, TXA2D, RQP2	RYCO M2, M2G						
HOSE SIZE		USE INSERT	C_A Adj.	C_A Adj.	C_A Adj.	C_A Adj.	C_A Adj.						
DN	inch	Dash	SERIES	PART NO	mm	PART NO	mm	PART NO	mm	PART NO	mm	PART NO	mm
5	3/16	-03	600-03										
6	1/4	-04	600-04	A00-04	-3	B00-04	-3	K00-04	0	L00-04	0	400-04	0
10	3/8	-06	600-06	A00-06	0	B00-06	-1	K00-06	0	L00-06	0	400-06	0
12	1/2	-08	600-08	A00-08	+3	B00-08	0	K00-08	+3	L00-08	0	400-08	0
16	5/8	-10	600-10			B00-10	+1	K00-10	+1	L00-10	0		
19	3/4	-12	600-12	A00-12	0	B00-12	0	K00-12	+2	L00-12	0	400-12	0
25	1	-16	600-16	A00-16	-4	B00-16	-2	K00-16	0	L00-16	0	400-16	-2
31	1.1/4	-20	600-20	A00-20	-2	B00-20	-4			L00-20	0		
38	1.1/2	-24	600-24	A00-24	+2	B00-24	0						
51	2	-32	600-32	A00-32	0	B00-32	0						

All Series (except V Series)

Field Attachable Inserts and Ferrules can be ordered individually, or as complete Couplings. Each Ferrule Series is specific to a hose type as detailed on the previous page.

For all Series, except V Series*, the following method is used:

Example 1

(a) Individually

To order 1/2" NPT male Insert and Ferrule for 1/2" two wire non-skive hose (T2A).

Order Insert **609-0808** (600 Series). See NPT 600 Series Inserts on page 208.

Order Ferrule **L00-08**.

L00 Series Ferrules are used on T2A hose; see table on the previous page, or table for Matched Couplings for T2A on page 31.

Dash Size -08 part of L00-08 comes from 1/2" hose = 8/16" = -08; or from the tables.

(b) Complete Coupling

Order **L09-0808**.

Simply replace the first character of the Insert part number with the first character of the Ferrule part number.

(replace 6 with L) = 609-0808 → L09-0808

609-0808 Insert

plus L00-08 Ferrule equals

L09-0808 complete Coupling

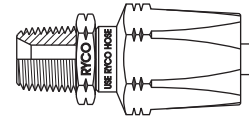
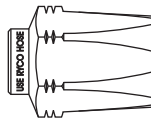
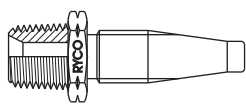

Example 2

(a) Individually

To order 3/4" -16 JIC female Insert and Ferrule for 3/8" RQP1 series hose.

Order Insert **604-0612** (600 Series). See JIC 600 Series Inserts on page 209.

Order Ferrule **K00-06**.

K00 Series Ferrules are used on RQP1 hose; see table on previous page, table for Matched Couplings for RQP1 on page 50.

Dash Size -06 part of K00-06 comes from 3/8" hose = 6/16" = -06; or from the tables.

(b) Complete Coupling

Order **K04-0612**.

Simply replace the first character of the Insert part number with the first character of the Ferrule part number.

(replace 6 with K) = 604-0612 → K04-0612

604-0612 Insert

plus K00-06 Ferrule equals

K04-0612 complete Coupling

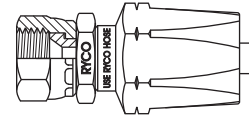
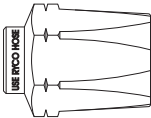
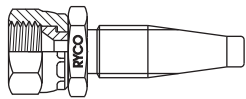

* See pages 188 and 189 for How To Order RYCO V00 Series Field Attachable Couplings for RQP5 and T5 Series Hose.

Cut-Off Allowance (C_A) Dimensions for Field Attachables

Due to differences in Ferrule design, many Cut-Off Allowance (C_A) dimensions vary between each Ferrule Series for the same matched Insert/Hose size.

The Cut-Off Allowance (C_A) dimensions published in "600 Series Field Attachable Inserts" section allow for the Ferrule being eased back 5/8 of a turn after the hose has bottomed in the ferrule, as per "Field Attachable Assembly Instructions" (ease back between 1/2 and 3/4 of a turn).

The Cut-Off Allowance (C_A) values for 600 Series Inserts, published in the tables on pages 204 to 219 are:

1. Up to and including -20 Size; the C_A is for **L00** Series (the most popular series)
2. For -24 and -32 Size; the C_A is for **B00** Series.

To determine the correct Cut-Off Allowance (C_A) for other Ferrule Series, use the published figure from pages 204 to 219, and adjust by the C_A Adjustment dimension listed in the table on the previous page.

EXAMPLE:

Determine the Cut-Off Allowance (C_A) for **K09-0808**.

From table on page 208, Cut-Off Allowance (C_A) for **609-0808** (L09-0808) is 42 mm.

From the table on the previous page, adjustment for **K00** Series in -08 size is "add 3 mm".

Cut-Off Allowance (C_A) for K09-0808 = 42 mm + 3 mm = 45 mm.

If the hose assembly length is critical, when calculating the Cut Length of hose, you must also allow for an increase in length of hose when the coupling is attached, due to compression within the coupling; see page 393.

For further information about Hose Assemblies and Cut-Off Allowances (C_A), see pages 392 to 398 of the Technical Section.

* For Cut-Off Allowances (C_A), and **V Series** Couplings, refer to pages 188 to 201.

Field Attachable Inserts for RYCO Hose Series T1A, T2A, T1D, T2D, TXA2D, RQG1, RQP1, RQP2, T1F, M2, M2G.

For V00 Series for RQP5 and T5 Hose Series, see pages 188 to 201.

600 Series Inserts are used with NON-SKIVE Ferrules K00, L00, V00, 400 Series; and SKIVE Ferrules A00, B00 Series.

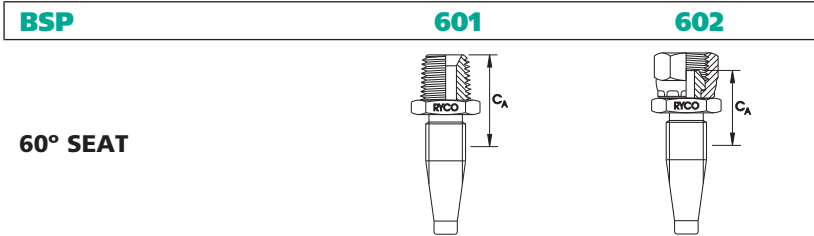

HOSE SIZE		THREAD SIZE	DASH SIZE	BSPT MALE		BSPP FEMALE	
DN	inch	inch		PART NO	C _A	PART NO	C _A
6	1/4	1/8	-0402	601-0402	31	602-0402	31
6	1/4	1/4	-0404	601-0404	35	602-0404	31
6	1/4	3/8	-0406	601-0406	35	602-0406	33
10	3/8	1/8	-0602	601-0602	28		
10	3/8	1/4	-0604	601-0604	32	602-0604	28
10	3/8	3/8	-0606	601-0606	32	602-0606	31
10	3/8	1/2	-0608	601-0608	38	602-0608	33
12	1/2	1/4	-0804	601-0804	37		
12	1/2	3/8	-0806	601-0806	37	602-0806	35
12	1/2	1/2	-0808	601-0808	42	602-0808	36
12	1/2	5/8	-0810				
12	1/2	3/4	-0812			602-0812	36
16	5/8	1/2	-1008	601-1008	45		
16	5/8	5/8	-1010	601-1010	45	602-1010	38
16	5/8	3/4	-1012	601-1012	44	602-1012	40
19	3/4	1/2	-1208				
19	3/4	3/4	-1212	601-1212	46	602-1212	38
19	3/4	1	-1216	601-1216	50	602-1216	42
25	1	1	-1616	601-1616	55	602-1616	46
31	1.1/4	1.1/4	-2020	601-2020	60	602-2020	53
38	1.1/2	1.1/2	-2424	601-2424	56	602-2424	46
51	2	2	-3232	601-3232	66	602-3232	62

Field Attachable Inserts for RYCO Hose Series T1A, T2A, T1D, T2D, TXA2D, RQG1, RQP1, RQP2, T1F, M2, M2G.

For V00 Series for RQP5 and T5 Hose Series, see pages 188 to 201.

600 Series Inserts are used with NON-SKIVE Ferrules K00, L00, V00, 400 Series; and SKIVE Ferrules A00, B00 Series.

BSP **632** **634**

60° SEAT

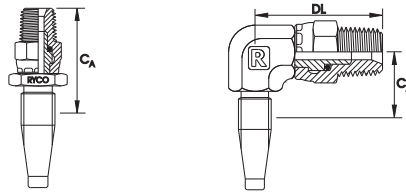

HOSE SIZE		THREAD SIZE	DASH SIZE	BSPT MALE SWIVEL	BSPT MALE SWIVEL 90° ELBOW			
DN	inch	inch		PART NO	CA	PART NO	CA	DL
10	3/8	3/8	-0606	632-0606	50	634-0606	24	41
10	3/8	1/2	-0608	632-0608	54	634-0608	24	45
12	1/2	1/2	-0808	632-0808	57	634-0808	32	47
19	3/4	3/4	-1212	632-1212	60			

These "Live Swivel" **632** and **634** Series Inserts are for Maximum Working Pressure:

- 350 bar (5100 psi) -06 Hose Size
- 280 bar (4060 psi) -08 & -12 Hose Size

Their swivel capability is to allow easy installation and orientation and avoid twisting of hose. They are not designed for continuous rotation or continuous movement.

BSP **602F** **605F**

SPECIAL SEATS

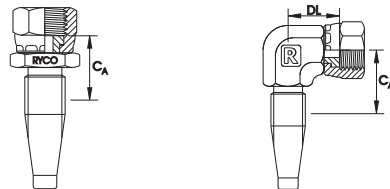

HOSE SIZE		THREAD SIZE	DASH SIZE	BSPP FEMALE FLAT FACE	BSPP FEMALE FLAT FACE 90° ELBOW			
DN	inch	inch		PART NO	CA	PART NO	CA	DL
6	1/4	1/4	-0404	602F-0404	28			
10	3/8	3/8	-0606	602F-0606	28			
10	3/8	1/2	-0608	602F-0608	29	605F-0608	24	21
12	1/2	1/2	-0808	602F-0808	32			
12	1/2	3/4	-0812	602F-0812	32			
19	3/4	3/4	-1212	602F-1212	34			
25	1	1	-1616					

Field Attachable Inserts for RYCO Hose Series T1A, T2A, T1D, T2D, TXA2D, RQG1, RQP1, RQP2, T1F, M2, M2G.

For V00 Series for RQP5 and T5 Hose Series, see pages 188 to 201.

600 Series Inserts are used with NON-SKIVE Ferrules K00, L00, V00, 400 Series; and SKIVE Ferrules A00, B00 Series.

BSP

612

631

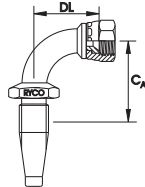
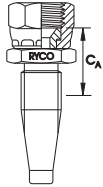

SPECIAL SEATS

HOSE SIZE	THREAD SIZE	DASH SIZE	BSP FEMALE 60° CONCAVE SEAT (JIS)	BSP FEMALE 60° CONCAVE SEAT (JIS) 90° TUBE BEND
-----------	-------------	-----------	-----------------------------------	---

DN	inch	inch		PART NO	C _A	PART NO	C _A	DL
6	1/4	1/4	-0404	612-0404	31			
10	3/8	3/8	-0606	612-0606	29	631-0606	40	37
10	3/8	1/2	-0608					
12	1/2	1/2	-0808	612-0808	33			
12	1/2	3/4	-0812					
19	3/4	3/4	-1212	612-1212	36			
25	1	1	-1616	612-1616	43			

Please note:
These **612** and **631** Series inserts are also listed in the JIS section on page 211.

BSP

606

605

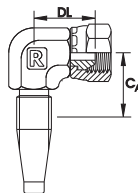
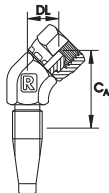

60° SEAT

HOSE SIZE	THREAD SIZE	DASH SIZE	BSP FEMALE 45° ELBOW	BSP FEMALE 90° ELBOW
-----------	-------------	-----------	----------------------	----------------------

DN	inch	inch		PART NO	C _A	DL	PART NO	C _A	DL
6	1/4	1/4	-0404	606-0404	40	15	605-0404	27	20
6	1/4	3/8	-0406				605-0406	26	22
10	3/8	3/8	-0606	606-0606	39	15	605-0606	24	23
10	3/8	1/2	-0608				605-0608	24	25
12	1/2	1/2	-0808	606-0808	48	16	605-0808	32	26
16	5/8	5/8	-1010	606-1010	50	17	605-1010	35	28
19	3/4	3/4	-1212	606-1212	48	16	605-1212	32	29
25	1	1	-1616	606-1616	60	19	605-1616	39	35
31	1.1/4	1.1/4	-2020	606-2020	65	24	605-2020	43	43
38	1.1/2	1.1/2	-2424	606-2424	72	29	605-2424	50	49
51	2	2	-3232	606-3232	85	32	605-3232	56	61

600 Series Field Attachable Inserts



Field Attachable Inserts for RYCO Hose Series T1A, T2A, T1D, T2D, TXA2D, RQG1, RQP1, RQP2, T1F, M2, M2G.

For V00 Series for RQP5 and T5 Hose Series, see pages 188 to 201.

600 Series Inserts are used with NON-SKIVE Ferrules K00, L00, V00, 400 Series; and SKIVE Ferrules A00, B00 Series.

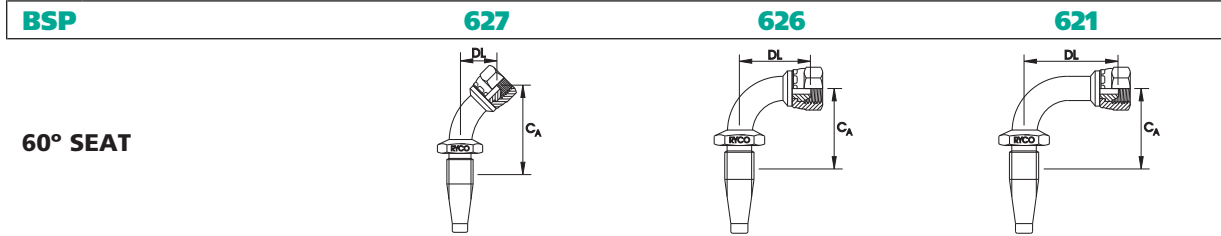

HOSE SIZE				THREAD SIZE	DASH SIZE	BSPP FEMALE 45° TUBE BEND			BSPP FEMALE 90° TUBE BEND			BSPP FEMALE 90° LONG TUBE BEND		
DN	inch	inch				PART NO	C _A	DL	PART NO	C _A	DL	PART NO	C _A	DL
6	1/4	1/4	-0404			627-0404	54	19	626-0404	43	35	621-0404	43	61
6	1/4	3/8	-0406											
10	3/8	3/8	-0606			627-0606	52	21	626-0606	40	37	621-0606	40	63
10	3/8	1/2	-0608						626-0608	45	44			
12	1/2	1/2	-0808			627-0808	61	23	626-0808	49	44	621-0808	49	71
12	1/2	5/8	-0810						626-0810	54	47	621-0810	54	74
16	5/8	5/8	-1010			627-1010	66	23	626-1010	56	47	621-1010	56	74
16	5/8	3/4	-1012											
19	3/4	3/4	-1212			627-1212	69	26	626-1212	60	53	621-1212	60	84
25	1	1	-1616			627-1616	88	32	626-1616	78	68	621-1616	78	102
31	1.1/4	1.1/4	-2020			627-2020	101	37	626-2020	93	80	621-2020	93	120
38	1.1/2	1.1/2	-2424											
51	2	2	-3232			627-3232	131	49	626-3232	126	114			

Intro

Hose

Couplings

Adaptors

Accessories

Filters

Technical

Field Attachable Inserts for RYCO Hose Series T1A, T2A, T1D, T2D, TXA2D, RQG1, RQP1, RQP2, T1F, M2, M2G.

For V00 Series for RQP5 and T5 Hose Series, see pages 188 to 201.

600 Series Inserts are used with NON-SKIVE Ferrules K00, L00, V00, 400 Series; and SKIVE Ferrules A00, B00 Series.

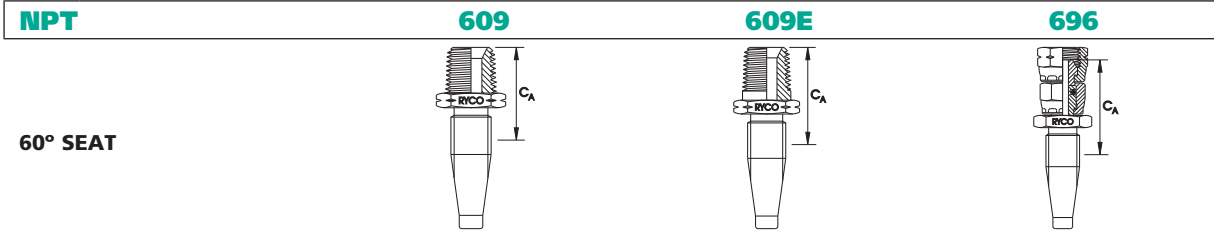

HOSE SIZE				THREAD SIZE	DASH SIZE	NPT MALE		NPT MALE EXTENDED		NPSM FEMALE LIVE SWIVEL	
DN	inch	inch		PART NO	C _A	PART NO	C _A	PART NO	C _A		
6	1/4	1/8	-0402	609-0402	31						
6	1/4	1/4	-0404	609-0404	35					696-0404	50
6	1/4	3/8	-0406	609-0406	35	609E-0406	43				
10	3/8	1/4	-0604	609-0604	32					696-0604	46
10	3/8	3/8	-0606	609-0606	32	609E-0606					
10	3/8	1/2	-0608	609-0608	38						
12	1/2	1/4	-0804							These "Live Swivel" 696 Series Inserts are for Maximum Working Pressure: 420 bar (6000 psi) -04 Hose Size 350 bar (5100 psi) -06 Hose Size Their swivel capability is to allow easy installation and orientation and avoid twisting of hose. They are not designed for continuous rotation or continuous movement.	
12	1/2	3/8	-0806	609-0806	37						
12	1/2	1/2	0808	609-0808	42						
12	1/2	3/4	-0812								
16	5/8	1/2	-1008	609-1008	45						
16	5/8	5/8	-1010								
16	5/8	3/4	-1012	609-1012	45						
19	3/4	1/2	-1208	609-1208	42						
19	3/4	3/4	-1212	609-1212	42						
19	3/4	1	-1216								
25	1	1	-1616	609-1616	55						
31	1.1/4	1.1/4	-2020	609-2020	60						
38	1.1/2	1.1/2	-2424	609-2424	56						
51	2	2	-3232	609-3232	66						

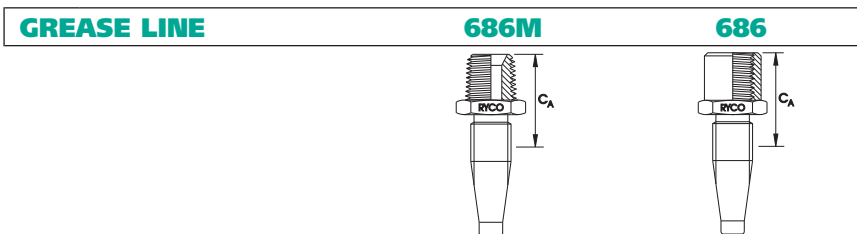

HOSE SIZE				THREAD SIZE	DASH SIZE	GREASE LINE MALE		GREASE LINE FIXED FEMALE	
DN	inch	inch		PART NO	C _A	PART NO	C _A	PART NO	C _A
6	1/4	1/2x27 TPI	-0408	686M-0408	32	686-0408	32		
10	3/8	1/2x27 TPI	-0608			686-0608	29		

600 Series Field Attachable Inserts



Field Attachable Inserts for RYCO Hose Series T1A, T2A, T1D, T2D, TXA2D, RQG1, RQP1, RQP2, T1F, M2, M2G.

For V00 Series for RQP5 and T5 Hose Series, see pages 188 to 201.

600 Series Inserts are used with NON-SKIVE Ferrules K00, L00, V00, 400 Series; and SKIVE Ferrules A00, B00 Series.

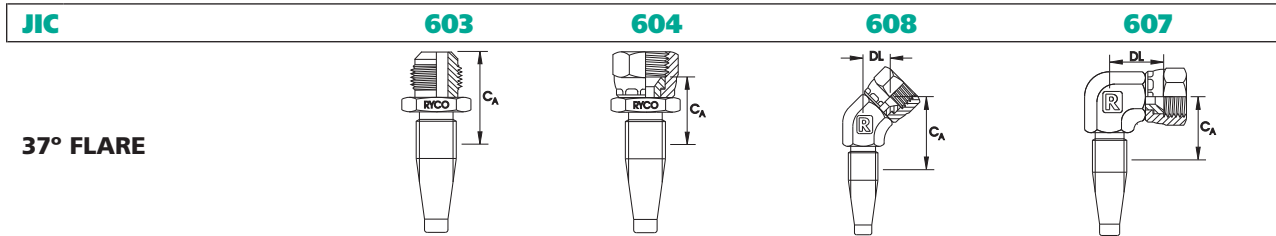

HOSE SIZE		THREAD SIZE	TUBE SIZE	DASH SIZE	JIC MALE	JIC FEMALE	JIC FEMALE 45° ELBOW	JIC FEMALE 90° ELBOW						
DN	inch	inch	inch		PART NO	C _A	PART NO	C _A	PART NO	C _A	DL	PART NO	C _A	DL
6	1/4	7/16	1/4	-0407	603-0407	35	604-0407	29	608-0407	38	14	607-0407	27	18
6	1/4	1/2	5/16	-0408	603-0408	35	604-0408	29	608-0408	38	14	607-0408	27	18
6	1/4	9/16	3/8	-0409	603-0409	35	604-0409	29	608-0409	38	14	607-0409	27	18
6	1/4	3/4	1/2	-0412	603-0412	39	604-0412	31						
10	3/8	7/16	1/4	-0607			604-0607	26				607-0607	26	19
10	3/8	1/2	5/16	-0608			604-0608	26						
10	3/8	9/16	3/8	-0609	603-0609	32	604-0609	26	608-0609	36	12	607-0609	24	20
10	3/8	3/4	1/2	-0612	603-0612	36	604-0612	29	608-0612	37	13	607-0612	24	21
10	3/8	7/8	5/8	-0614	603-0614	38	604-0614	30						
12	1/2	9/16	3/8	-0809			604-0809	31						
12	1/2	3/4	1/2	-0812	603-0812	39	604-0812	32	608-0812	46	15	607-0812	32	22
12	1/2	7/8	5/8	-0814	603-0814	41	604-0814	33	608-0814	46	13	607-0814	32	23
12	1/2	1.1/16	3/4	-0817	603-0817	46	604-0817	36	608-0817	48	15	607-0817	32	25
16	5/8	7/8	5/8	-1014	603-1014	45	604-1014	36	608-1014	49	19	607-1014	33	27
16	5/8	1.1/16	3/4	-1017	603-1017	48	604-1017	38	608-1017	48	14	607-1017	33	28
19	3/4	7/8	5/8	-1214			604-1214	36						
19	3/4	1.1/16	3/4	-1217	603-1217	46	604-1217	36	608-1217	48	15	607-1217	32	28
19	3/4	1.3/16	7/8	-1219	603-1219	47	604-1219	38				607-1219	31	28
19	3/4	1.5/16	1	-1221	603-1221	49	604-1221	39						
25	1	1.1/16	3/4	-1617	603-1617	52	604-1617	43						
25	1	1.5/16	1	-1621	603-1621	53	604-1621	43	608-1621	58	18	607-1621	39	32
25	1	1.5/8	1.1/4	-1626	603-1626	56	604-1626	44						
31	1.1/4	1.5/8	1.1/4	-2026	603-2026	60	604-2026	49	608-2026	62	21	607-2026	43	37
38	1.1/2	1.7/8	1.1/2	-2430			604-2430	50						
51	2	2.1/2	2	-3240			604-3240	61						

Field Attachable Inserts for RYCO Hose Series T1A, T2A, T1D, T2D, TXA2D, RQG1, RQP1, RQP2, T1F, M2, M2G.

For V00 Series for RQP5 and T5 Hose Series, see pages 188 to 201.

600 Series Inserts are used with NON-SKIVE Ferrules K00, L00, V00, 400 Series; and SKIVE Ferrules A00, B00 Series.

JIC

625

624

628

37° FLARE

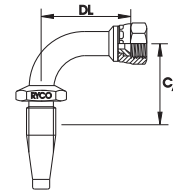
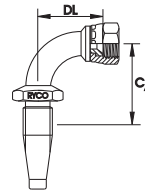
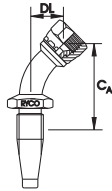

HOSE SIZE		THREAD SIZE	TUBE SIZE	DASH SIZE	JIC FEMALE 45° TUBE BEND			JIC FEMALE 90° TUBE BEND			JIC FEMALE 90° LONG BEND		
DN	inch	inch	inch		PART NO	C _A	DL	PART NO	C _A	DL	PART NO	C _A	DL
6	1/4	7/16	1/4	-0407	625-0407	53	18	624-0407	43	33	628-0407	43	59
6	1/4	1/2	5/16	-0408	625-0408	53	18	624-0408	43	33	628-0408	43	59
6	1/4	9/16	3/8	-0409	625-0409	53	18	624-0409	43	34	628-0409	43	60
6	1/4	3/4	1/2	-0412									
10	3/8	7/16	1/4	-0607									
10	3/8	1/2	5/16	-0608									
10	3/8	9/16	3/8	-0609	625-0609	50	18	624-0609	40	34	628-0609	40	60
10	3/8	3/4	1/2	-0612	625-0612	54	20	624-0612	45	40	628-0612	45	67
10	3/8	7/8	5/8	-0614									
12	1/2	9/16	3/8	-0809									
12	1/2	3/4	1/2	-0812	625-0812	59	20	624-0812	49	40	628-0812	49	67
12	1/2	7/8	5/8	-0814	625-0814	63	23	624-0814	54	46	628-0814	54	74
12	1/2	1.1/16	3/4	-0817									
16	5/8	7/8	5/8	-1014	625-1014	65	24	624-1014	56	46	628-1014	56	74
16	5/8	1.1/16	3/4	-1017	625-1017	69	25	624-1017	61	52	628-1017	61	82
19	3/4	7/8	5/8	-1214									
19	3/4	1.1/16	3/4	-1217	625-1217	68	25	624-1217	60	52	628-1217	60	82
19	3/4	1.3/16	7/8	-1219	625-1219	68	25	624-1219	60	52			
19	3/4	1.5/16	1	-1221	625-1221	81	30	624-1221	74	65			
25	1	1.1/16	3/4	-1617				624-1617	78	64			
25	1	1.5/16	1	-1621	625-1621	86	30	624-1621	78	67	628-1621	78	101
25	1	1.5/8	1.1/4	-1626									
31	1.1/4	1.5/8	1.1/4	-2026	625-2026	98	33	624-2026	93	75	628-2026	93	116
38	1.1/2	1.7/8	1.1/2	-2430	625-2430	104	40				628-2430	98	139
51	2	2.1/2	2	-3240									

Field Attachable Inserts for RYCO Hose Series T1A, T2A, T1D, T2D, TXA2D, RQG1, RQP1, RQP2, T1F, M2, M2G.

For V00 Series for RQP5 and T5 Hose Series, see pages 188 to 201.

600 Series Inserts are used with NON-SKIVE Ferrules K00, L00, V00, 400 Series; and SKIVE Ferrules A00, B00 Series.

JIS **612** **631**

JAPANESE INDUSTRIAL STANDARD (JIS)

**BSPP THREAD FORM
60° CONCAVE SEAT**

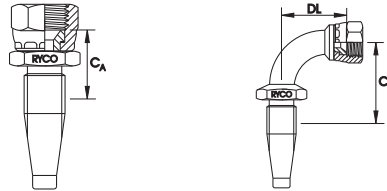

HOSE SIZE	THREAD SIZE	DASH SIZE	BSPP FEMALE 60° CONCAVE SEAT (JIS)	BSPP FEMALE 60° CONCAVE SEAT (JIS) 90° TUBE BEND
-----------	-------------	-----------	---------------------------------------	--

DN	inch	inch		PART NO	CA	PART NO	CA	DL
6	1/4	1/4	-0404	612-0404	31			
10	3/8	3/8	-0606	612-0606	29	631-0606	40	37
10	3/8	1/2	-0608					
12	1/2	1/2	-0808	612-0808	33			
12	1/2	3/4	-0812					
19	3/4	3/4	-1212	612-1212	36			
25	1	1	-1616	612-1616	43			

Please note:

These **612** and **631** Series inserts are also listed in the BSP section on page 206.

JIS **668**

JAPANESE INDUSTRIAL STANDARD (JIS)

**"KOMATSU"
METRIC THREAD FORM
60° CONCAVE SEAT**

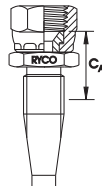

HOSE SIZE	THREAD SIZE	DASH SIZE	METRIC FEMALE 60 CONCAVE SEAT (JIS)
-----------	-------------	-----------	---

DN	inch	mm		PART NO	CA
6	1/4	14x1,5	-0414	668-0414	33
10	3/8	18x1,5	-0618	668-0618	27
10	3/8	22x1,5	-0622	668-0622	30
12	1/2	22x1,5	-0822	668-0822	33
12	1/2	24x1,5	-0824	668-0824	33
16	5/8	24x1,5	-1024	668-1024	37
16	5/8	30x1,5	-1030	668-1030	37
19	3/4	24x1,5	-1224	668-1224	36
19	3/4	30x1,5	-1230	668-1230	36
19	3/4	33x1,5	-1233	668-1233	39
25	1	33x1,5	-1633	668-1633	41

Please note:

These **668** Series inserts are also listed in the METRIC section on page 213.

Field Attachable Inserts for RYCO Hose Series T1A, T2A, T1D, T2D, TXA2D, RQG1, RQP1, RQP2, T1F, M2, M2G.

For V00 Series for RQP5 and T5 Hose Series, see pages 188 to 201.

600 Series Inserts are used with NON-SKIVE Ferrules K00, L00, V00, 400 Series; and SKIVE Ferrules A00, B00 Series.

METRIC

DKL METRIC (LIGHT)

RYCO DKL Female Swivels up to M26 size have Multiseal DKL 24° and DKM 60° Cone. M30 and over have DKL 24° Cone only.

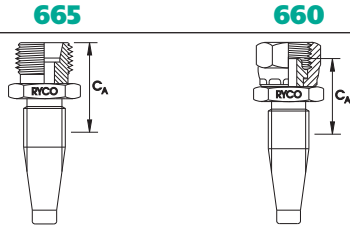

HOSE SIZE	THREAD SIZE	TUBE SIZE	DASH SIZE	DKL MALE 24° CONE	DKL FEMALE 24°/60° CONE
6	1/4	12x1,5	6	-0412	
6	1/4	14x1,5	8	-0414	
6	1/4	16x1,5	10	-0416	
10	3/8	16x1,5	10	-0616	
10	3/8	18x1,5	12	-0618	
12	1/2	18x1,5	12	-0818	
12	1/2	22x1,5	15	-0822	
12	1/2	26x1,5	18	-0826	
16	5/8	26x1,5	18	-1026	
19	3/4	30x2,0	22	-1230	
25	1	36x2,0	28	-1636	
31	1.1/4	45x2,0	35	-2045	

METRIC

DKL METRIC (LIGHT)

RYCO DKL Female Swivels up to M26 size have Multiseal DKL 24° and DKM 60° Cone. M30 and over have DKL 24° Cone only.

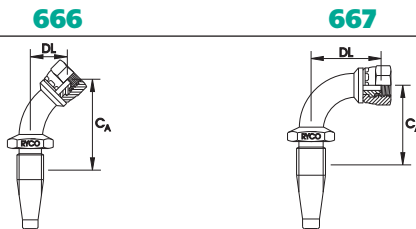

HOSE SIZE	THREAD SIZE	TUBE SIZE	DASH SIZE	DKL FEMALE 24°/60° CONE 45° TUBE BEND	DKL FEMALE 24°/60° CONE 90° TUBE BEND
6	1/4	12x1,5	6	-0412	
6	1/4	14x1,5	8	-0414	
10	3/8	16x1,5	10	-0616	
10	3/8	18x1,5	12	-0618	
12	1/2	18x1,5	12	-0818	
12	1/2	22x1,5	15	-0822	
12	1/2	26x1,5	18	-0826	
16	5/8	26x1,5	18	-1026	
19	3/4	30x2,0	22	-1230	
25	1	36x2,0	28	-1636	
31	1.1/4	45x2,0	35	-2045	

600 Series Field Attachable Inserts



Field Attachable Inserts for RYCO Hose Series T1A, T2A, T1D, T2D, TXA2D, RQG1, RQP1, RQP2, T1F, M2, M2G.

For V00 Series for RQP5 and T5 Hose Series, see pages 188 to 201.

600 Series Inserts are used with NON-SKIVE Ferrules K00, L00, V00, 400 Series; and SKIVE Ferrules A00, B00 Series.

METRIC											
DKS/DKOS METRIC O RING (HEAVY)											
24° CONE											
				663		671		672			
HOSE SIZE	THREAD SIZE	TUBE SIZE	DASH SIZE	DKS MALE 24° CONE	DKOS FEMALE 24° CONE	DKOS FEMALE 24° CONE 45° TUBE BEND					
DN	inch	mm	mm	PART NO	C _A	PART NO	C _A	PART NO	C _A	DL	
6	1/4	16x1,5	8	-0416	663-0416	33	671-0416	34	672-0416	58	23
6	1/4	18x1,5	10	-0418	663-0418	33	671-0418	34	672-0418	58	23
10	3/8	20x1,5	12	-0620	663-0620	29	671-0620	33	672-0620	60	26
10	3/8	22x1,5	14	-0622	663-0622	33	671-0622	36	672-0622	61	27
12	1/2	24x1,5	16	-0824	663-0824	36	671-0824	40	672-0824	70	30
19	3/4	30x2,0	20	-1230	663-1230	40	671-1230	44	672-1230	76	33
19	3/4	36x2,0	25	-1236	663-1236	44	671-1236	47	672-1236	89	38
25	1	42x2,0	30	-1642	663-1642	49	671-1642				
31	1.1/4	52x2,0	38	-2052			671-2052				

METRIC												
DKOS METRIC O RING (HEAVY)												
24° CONE												
				673								
HOSE SIZE	THREAD SIZE	TUBE SIZE	DASH SIZE	DKOS FEMALE 24° CONE 90° TUBE BEND								
DN	inch	mm	mm	PART NO	C _A	DL						
6	1/4	16x1,5	8	-0416	673-0416	43	41					
6	1/4	18x1,5	10	-0418	673-0418	43	41					
10	3/8	20x1,5	12	-0620	673-0620	45	48					
10	3/8	22x1,5	14	-0622	673-0622	45	50					
12	1/2	24x1,5	16	-0824	673-0824	54	56					
16	5/8	30x2,0	20	-1030								
19	3/4	30x2,0	20	-1230	673-1230	60	63					
19	3/4	36x2,0	25	-1236	673-1236	74	76					
25	1	42x2,0	30	-1642								
31	1.1/4	52x2,0	38	-2052								

METRIC											
JAPANESE INDUSTRIAL STANDARD (JIS)											
"KOMATSU" METRIC THREAD FORM 60° CONCAVE SEAT											
				668							
HOSE SIZE	THREAD SIZE	TUBE SIZE	DASH SIZE	METRIC FEMALE 60° CONCAVE SEAT (JIS)							
DN	inch	mm	DASH SIZE	PART NO	C _A						
6	1/4	14x1,5	-0414	668-0414	33						
10	3/8	18x1,5	-0618	668-0618	27						
10	3/8	22x1,5	-0622	668-0622	30						
12	1/2	22x1,5	-0822	668-0822	33						
12	1/2	24x1,5	-0824	668-0824	33						
16	5/8	24x1,5	-1024	668-1024	37						
16	5/8	30x1,5	-1030	668-1030	37						
19	3/4	24x1,5	-1224	668-1224	36						
19	3/4	30x1,5	-1230	668-1230	36						
19	3/4	33x1,5	-1233	668-1233	39						
25	1	33x1,5	-1633	668-1633	41						

Please note:

These 668 Series inserts are also listed in the JIS section on page 211.

Field Attachable Inserts for RYCO Hose Series T1A, T2A, T1D, T2D, TXA2D, RQG1, RQP1, RQP2, T1F, M2, M2G.

For V00 Series for RQP5 and T5 Hose Series, see pages 188 to 201.

600 Series Inserts are used with NON-SKIVE Ferrules K00, L00, V00, 400 Series; and SKIVE Ferrules A00, B00 Series.

ORFS

680

O RING
FACE SEAL

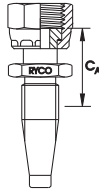

HOSE SIZE		THREAD SIZE	TUBE SIZE	DASH SIZE	ORFS FEMALE	
DN	inch	inch	inch		PART NO	C _A
6	1/4	9/16	1/4	-0409	680-0409	38
6	1/4	11/16	3/8	-0411	680-0411	40
10	3/8	11/16	3/8	-0611	680-0611	36
10	3/8	13/16	1/2	-0613	680-0613	39
12	1/2	13/16	1/2	-0813	680-0813	41
12	1/2	1	5/8	-0816	680-0816	47
16	5/8	1	5/8	-1016	680-1016	49
16	5/8	1.3/16	3/4	-1019	680-1019	52
19	3/4	1.3/16	3/4	-1219	680-1219	50
19	3/4	1.7/16	1	-1223	680-1223	61
25	1	1.7/16	1	-1623	680-1623	65
31	1.1/4	1.11/16	1.1/4	-2027	680-2027	72

ORFS

681

682

683

O RING
FACE SEAL

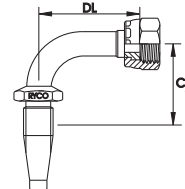
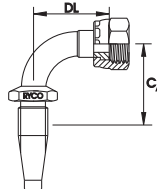
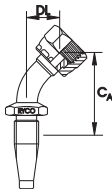

HOSE SIZE		THREAD SIZE	TUBE SIZE	DASH SIZE	ORFS FEMALE 45° TUBE BEND			ORFS FEMALE 90° TUBE BEND			ORFS FEMALE 90° LONG BEND		
DN	inch	inch	inch		PART NO	C _A	DL	PART NO	C _A	DL	PART NO	C _A	DL
6	1/4	9/16	1/4	-0409	681-0409	47	14	682-0409	39	25	683-0409	39	46
6	1/4	11/16	3/8	-0411	681-0411	51	16	682-0411	43	31	683-0411	43	57
10	3/8	11/16	3/8	-0611	681-0611	48	16	682-0611	40	31	683-0611	40	57
10	3/8	13/16	1/2	-0613	681-0613	53	19	682-0613	45	38	683-0613	45	65
12	1/2	13/16	1/2	-0813	681-0813	57	19	682-0813	49	38	683-0813	49	65
12	1/2	1	5/8	-0816	681-0816	61	20	682-0816	54	43	683-0816	54	70
16	5/8	1	5/8	-1016	681-1016	63	20	682-1016	56	43	683-1016	56	70
16	5/8	1.3/16	3/4	-1019	681-1019	67	23	682-1019	61	49	683-1019	61	79
19	3/4	1.3/16	3/4	-1219	681-1219	66	23	682-1219	60	49	683-1219	60	79
19	3/4	1.7/16	1	-1223	681-1223	79	28	682-1223	74	61	683-1223	74	95
25	1	1.7/16	1	-1623	681-1623	83	28	682-1623	78	61	683-1623	78	95
31	1.1/4	1.11/16	1.1/4	-2027	681-2027	95	30	682-2027	93	71	683-2027	93	111

600 Series Field Attachable Inserts



Field Attachable Inserts for RYCO Hose Series T1A, T2A, T1D, T2D, TXA2D, RQG1, RQP1, RQP2, T1F, M2, M2G.

For V00 Series for RQP5 and T5 Hose Series, see pages 188 to 201.

600 Series Inserts are used with NON-SKIVE Ferrules K00, L00, V00, 400 Series; and SKIVE Ferrules A00, B00 Series.

SAE					653		654		658			657		
45° FLARE														
HOSE SIZE	THREAD SIZE	TUBE SIZE	DASH SIZE		SAE MALE		SAE FEMALE		SAE FEMALE 45° ELBOW			SAE FEMALE 90° ELBOW		
DN	inch	inch	inch		PART NO	C _A	PART NO	C _A	PART NO	C _A	DL	PART NO	C _A	DL
6	1/4	7/16	1/4	-0407			654-0407	29						
6	1/4	1/2	5/16	-0408			654-0408	29						
6	1/4	5/8	3/8	-0410	653-0410	37	654-0410	29						
10	3/8	1/2	5/16	-0608	653-0608	32	654-0608	26	658-0608	35	10	657-0608	26	19
10	3/8	5/8	3/8	-0610	653-0610	33	654-0610	26	658-0610	36	11	657-0610	24	19
10	3/8	3/4	1/2	-0612			654-0612	29						
12	1/2	3/4	1/2	-0812			654-0812	32						
12	1/2	7/8	5/8	-0814			654-0814	32						
19	3/4	1.1/16	3/4	-1217			654-1217	36						

SAE					655			656			656L		
45° FLARE													
HOSE SIZE	THREAD SIZE	TUBE SIZE	DASH SIZE		SAE FEMALE 45° TUBE BEND		SAE FEMALE 90° TUBE BEND		SAE FEMALE 90° LONG TUBE BEND				
DN	inch	inch	inch		PART NO	C _A	DL	PART NO	C _A	DL	PART NO	C _A	DL
10	3/8	1/2	5/16	-0608	655-0608	49	18						
10	3/8	5/8	3/8	-0610	655-0610	50	18	656-0610	40	34	656L-0610	40	60

SAE					674		678			679		
INVERTED MALE FLARE												
HOSE SIZE	THREAD SIZE	TUBE SIZE	DASH SIZE		SAE INVERTED MALE FLARE		SAE INVERTED MALE FLARE 90° ELBOW		SAE INVERTED MALE FLARE 90° EXTENDED ELBOW			
DN	inch	inch	inch		PART NO	C _A	PART NO	C _A	DL	PART NO	C _A	DL
6	1/4	7/16	1/4	-0407	674-0407	50						
10	3/8	5/8	3/8	-0610	674-0610	47	678-0610	26	32	679-0610	26	60
10	3/8	11/16	7/16	-0611	674-0611	50	678-0611	26	36			

Field Attachable Inserts for RYCO Hose Series T1A, T2A, T1D, T2D, TXA2D, RQG1, RQP1, RQP2, T1F, M2, M2G.

For V00 Series for RQP5 and T5 Hose Series, see pages 188 to 201.

600 Series Inserts are used with NON-SKIVE Ferrules K00, L00, V00, 400 Series; and SKIVE Ferrules A00, B00 Series.

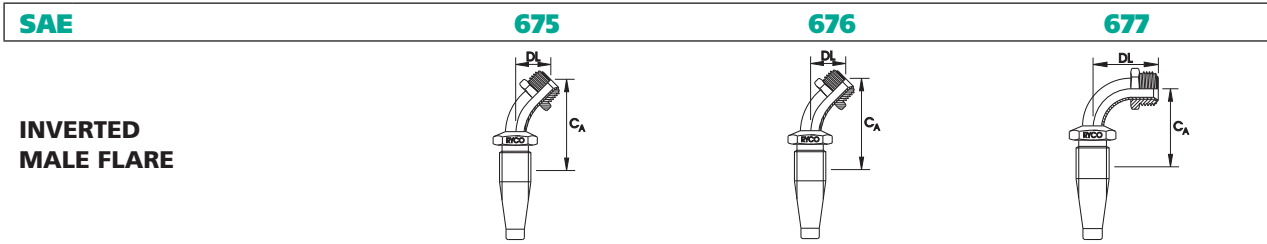

HOSE SIZE		THREAD SIZE	TUBE SIZE	DASH SIZE	SAE INVERTED MALE FLARE 45° TUBE BEND			SAE INVERTED MALE FLARE 60° TUBE BEND			SAE INVERTED MALE FLARE 90° TUBE BEND		
DN	inch	inch	inch		PART NO	C _A	DL	PART NO	C _A	DL	PART NO	C _A	DL
6	1/4	7/16	1/4	-0407				676-0407	72	29	677-0407	53	38
10	3/8	5/8	3/8	-0610	675-0610	79	23				677-0610	61	50
10	3/8	11/16	7/16	-0611									

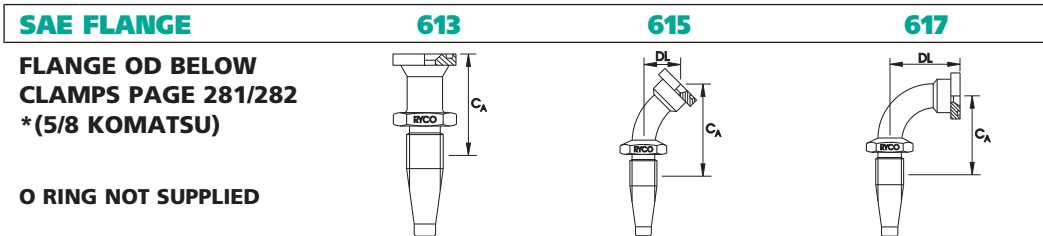

HOSE SIZE		NOM. FLANGE SIZE	DASH SIZE	CODE 61 FLANGE	CODE 61 FLANGE 45° TUBE BEND			CODE 61 FLANGE 90° TUBE BEND			
DN	inch	inch		PART NO	C _A	PART NO	C _A	DL	PART NO	C _A	DL
12	1/2	1/2	-0808	613-0808	52	615-0808	66	19	617-0808	70	40
12	1/2	3/4	-0812	613-0812	52	615-0812	66	19	617-0812	70	40
16	5/8	*5/8	-1010	613-1010	58	615-1010	69	20	617-1010	74	42
19	3/4	3/4	-1212	613-1212	57	615-1212	71	22	617-1212	78	48
19	3/4	1	-1216	613-1216	58	615-1216	72	23	617-1216	79	49
19	3/4	1.1/4	-1220	613-1220	58	615-1220	86	26	617-1220	94	59
25	1	3/4	-1612						617-1612	83	49
25	1	1	-1616	613-1616	69	615-1616	90	26	617-1616	98	59
25	1	1.1/4	-1620	613-1620	69	615-1620	90	26	617-1620	98	59
25	1	1.1/2	-1624	613-1624	68	615-1624	98	28	617-1624	107	68
31	1.1/4	1	-2016	613-2016	75	615-2016	101	28	617-2016	111	68
31	1.1/4	1.1/4	-2020	613-2020	75	615-2020	101	28	617-2020	111	68
31	1.1/4	1.1/2	-2024	613-2024	75	615-2024	99	28	617-2024	111	68
38	1.1/2	1.1/2	-2424	613-2424	73	615-2424	103	31	617-2424	114	77
38	1.1/2	2	-2432	613-2432	74				617-2432	115	79
51	2	2	-3232	613-3232	98	615-3232	131	38	617-3232	141	99

Dimensions for SAE Code 61 and Code 62 Flanges

NOM. FLANGE SIZE	inch	1/2	*5/8	3/4	1	1.1/4	1.1/2	2	2.1/2	
CODE 61	B	mm	30,2	34,0	38,1	44,5	50,8	60,3	71,4	84,1
	T	mm	6,73	6,73	6,73	8,00	8,00	8,00	9,53	9,53
CODE 62	B	mm	31,8		41,3	47,6	54,0	63,5	79,4	
	T	mm	7,75		8,76	9,53	10,29	12,57	12,57	

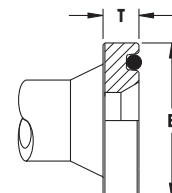

*5/8 is used by Komatsu.

Field Attachable Inserts for RYCO Hose Series T1A, T2A, T1D, T2D, TXA2D, RQG1, RQP1, RQP2, T1F, M2, M2G.

For V00 Series for RQP5 and T5 Hose Series, see pages 188 to 201.

600 Series Inserts are used with NON-SKIVE Ferrules K00, L00, V00, 400 Series; and SKIVE Ferrules A00, B00 Series.

SALVAGE

623

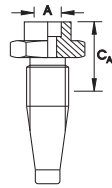

TUBE WELD

STANDPIPE

618

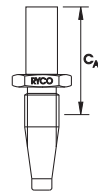

IMPERIAL

HOSE SIZE		A	DASH SIZE	SALVAGE (LIVESAVER)	
DN	inch	inch		PART NO	C _A
6	1/4	1/4	-0404	623-0404	28
6	1/4	5/16	-0405		
6	1/4	3/8	-0406	623-0406	28
10	3/8	1/4	-0604		
10	3/8	3/8	-0606	623-0606	24
10	3/8	1/2	-0608	623-0608	24
12	1/2	1/2	-0808	623-0808	29
12	1/2	5/8	-0810	623-0810	29
12	1/2	3/4	-0812	623-0812	29
16	5/8	5/8	-1010	623-1010	31
16	5/8	3/4	-1012	623-1012	31
16	5/8	1	-1016		
19	3/4	5/8	-1210		
19	3/4	3/4	-1212	623-1212	30
19	3/4	1	-1216	623-1216	34
25	1	3/4	-1612	623-1612	37
25	1	1	-1616	623-1616	39
25	1	1.1/4	-1620	623-1620	40
31	1.1/4	1.1/4	-2020	623-2020	44
38	1.1/2	1.1/2	-2424	623-2424	39
38	2	2	-3232	623-3232	50

HOSE SIZE		TUBE SIZE	DASH SIZE	IMPERIAL STANDPIPE	
DN	inch	inch		PART NO	C _A
6	1/4	5/16	-0405	618-0405	43
6	1/4	3/8	-0406	618-0406	44
10	3/8	1/4	-0604		
10	3/8	3/8	-0606	618-0606	41
10	3/8	1/2	-0608	618-0608	41
12	1/2	1/2	-0808	618-0808	52
12	1/2	5/8	-0810	618-0810	52
12	1/2	3/4	-0812		
16	5/8	5/8	-1010		
16	5/8	3/4	-1012	618-1012	60
16	5/8	1	-1016		
19	3/4	3/4	-1212	618-1212	66
19	3/4	7/8	-1214	618-1214	66
19	3/4	1	-1216		
25	1	3/4	-1612		
25	1	1	-1616	618-1616	70
25	1	1.1/4	-1620		
31	1.1/4	1.1/4	-2020	618-2020	81

Field Attachable Inserts for RYCO Hose Series T1A, T2A, T1D, T2D, TXA2D, RQG1, RQP1, RQP2, T1F, M2, M2G.

For V00 Series for RQP5 and T5 Hose Series, see pages 188 to 201.

600 Series Inserts are used with NON-SKIVE Ferrules K00, L00, V00, 400 Series; and SKIVE Ferrules A00, B00 Series.

STANDPIPE

664

METRIC

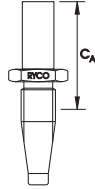

HOSE SIZE	TUBE SIZE	DASH SIZE	METRIC STANDPIPE
-----------	-----------	-----------	------------------

DN	inch	mm		PART NO	C _A
6	1/4	6	-0406	664-0406	43
6	1/4	8	-0408	664-0408	43
6	1/4	10	-0410	664-0410	44
10	3/8	10	-0610	664-0610	40
10	3/8	12	-0612	664-0612	40
10	3/8	14	-0614	664-0614	46
12	1/2	15	-0815	664-0815	47
12	1/2	16	-0816	664-0816	52
16	5/8	16	-1016	664-1016	54
16	5/8	18	-1018		
16	5/8	20	-1020		
19	3/4	20	-1220	664-1220	60
19	3/4	22	-1222	664-1222	52
19	3/4	25	-1225		
25	1	28	-1628		
25	1	30	-1630	664-1630	74
31	1.1/4	38	-2038		

Note: See page 273 for DKL and DKS Metric Nuts and Olives for use with Metric Standpipe Fittings

TUBE BITE

685

COMPLETE WITH NUT AND FLARELESS OLIVE

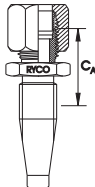

HOSE SIZE	TUBE SIZE	DASH SIZE	TUBE BITE
-----------	-----------	-----------	-----------

DN	inch	inch		PART NO	C _A
10	3/8	3/8	-0606	685-0606	32

Field Attachable Inserts for RYCO Hose Series T1A, T2A, T1D, T2D, TXA2D, RQG1, RQP1, RQP2, T1F, M2, M2G.

For V00 Series for RQP5 and T5 Hose Series, see pages 188 to 201.

600 Series Inserts are used with NON-SKIVE Ferrules K00, L00, V00, 400 Series; and SKIVE Ferrules A00, B00 Series.

UNO (O RING BOSS)

O RING SUPPLIED

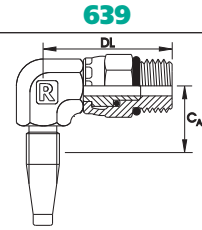
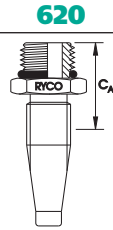

HOSE SIZE		THREAD SIZE	TUBE SIZE	DASH SIZE	UN O RING MALE	UN O RING MALE SWIVEL	UN O RING MALE SWIVEL 90° ELBOW				
DN	inch	inch	inch		PART NO	C _A	PART NO	C _A	PART NO	C _A	DL
6	1/4	9/16	3/8	-0409	620-0409	31	638-0409	44	639-0409	26	33
6	1/4	3/4	1/2	-0412					639-0412	26	36
10	3/8	9/16	3/8	-0609	620-0609	27			639-0609	24	34
10	3/8	3/4	1/2	-0612	620-0612	30	638-0612	47	639-0612	24	38
10	3/8	7/8	5/8	-0614	620-0614	32			639-0614	24	41
12	1/2	3/4	1/2	-0812	620-0812	33			639-0812	32	40
12	1/2	7/8	5/8	-0814	620-0814	35	638-0814	51	639-0814	32	41
12	1/2	1.1/16	3/4	-0817	620-0817	39					
16	5/8	7/8	5/8	-1014	620-1014	37	638-1014	53			
16	5/8	1.1/16	3/4	-1017	620-1017	41					
16	5/8	1.5/16	1	-1021	620-1021	43					
19	3/4	1.1/16	3/4	-1217	620-1217	39					
19	3/4	1.5/16	1	-1221	620-1221	41					
25	1	1.1/16	3/4	-1617	620-1617	50					
25	1	1.3/16	7/8	-1619	620-1619	45					
25	1	1.5/16	1	-1621	620-1621	45					
25	1	1.5/8	1.1/4	-1626							

These "Live Swivel" 638 and 639 Series Inserts are for Maximum Working Pressure:

- 420 bar (6000 psi) -04 Hose Size
- 350 bar (5100 psi) -06 Hose Size
- 280 bar (4060 psi) -08 & -10 Hose Size

Their swivel capability is to allow easy installation and orientation and avoid twisting of hose. They are not designed for continuous rotation or continuous movement.